



SPRIT-TYPE AIR CONDITIONERS

OPERATING INSTRUCTIONS

- MSH-09NV**
- MSH-12NV**
- MSH-18NV**
- MSH-24NV**

CONTENTS

| | |
|---|----|
| SAFETY PRECAUTIONS | 1 |
| NAME OF EACH PART | 5 |
| PREPARATION BEFORE OPERATION | 7 |
| "I FEEL..." AUTO OPERATION | 9 |
| MANUAL OPERATION (COOL, DRY, HEAT) | 11 |
| AIRFLOW VELOCITY AND DIRECTION ADJUSTMENT | 13 |
| SLEEP MODE | 15 |
| SWING OPERATION | 16 |
| TIMER OPERATION (ON/OFF TIMER) | 17 |
| WHEN THE AIR CONDITIONER IS NOT GOING TO BE USED FOR A LONG TIME | 18 |
| MAINTENANCE | 19 |
| CLEANING THE AIR FILTER/DEODORIZING FILTER .. | 20 |
| REPLACEMENT OF THE DEODORIZING FILTER/ AIR CLEANING FILTER | 21 |
| BEFORE CONTACTING THE SERVICE MAN, CHECK THE FOLLOWING AGAIN | 22 |
| WHEN YOU THINK THAT TROUBLE HAS OCCURED | 23 |
| INSTALLATION, RELOCATION AND INSPECTION ... | 25 |

For customers

Thank you very much for purchasing this Mitsubishi room air conditioner.

- To use this unit correctly and safely, be sure to read this instruction manual before use. Keep this manual carefully for later reference.
- Be sure to receive a guarantee card from your dealer and check that the purchased data and shop name, etc. are entered correctly.
- This air conditioner should not be installed by the customer (Safety and performance functions cannot be assured).

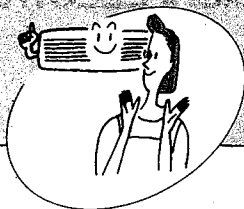

SAFETY PRECAUTIONS

- Before using the unit, carefully read these "Safety precautions" and use correctly.
- Since these cautionary items shown here are important for safety, be sure to observe them. Marks and their meanings are as shown below.

| | |
|--------------------|--|
| WARNING | <p>Incorrect handling could cause a serious hazard, such as death, serious injury, etc. with a high probability.</p> |
| CAUTION | <p>Incorrect handling could cause a serious hazard depending on the conditions.</p> |

Meanings of symbols used in this manual are as shown below.

| | |
|--|--|
| | <p>Be sure not to do.</p> |
| | <p>Be sure to follow the instruction.</p> |
| | <p>Be sure to ground.</p> |
| | <p>Be sure to disconnect the power plug.</p> |
| | <p>Never onto the indoor/outdoor unit to put anything on them.</p> |
| | <p>Danger of an electric shock be careful.</p> |
| | <p>Never insert your finger or a stick, etc.</p> |

- After reading this manual, keep it together with the installation manual in handy place for easy reference.

Do not connect using branched outlet or an extension cord, and do not attach many loads to one electric outlet.

- A fire or electric shock may result from poor contact, poor insulation, exceeding the permissible current, etc.

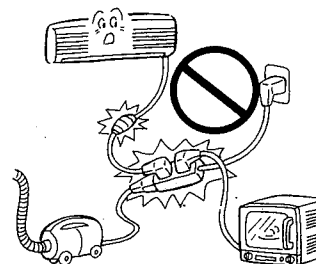

Remove dirt from the power plug and securely insert into the outlet.

- If dirt adheres to the plug or insertion is incomplete, it may cause a fire or electric shock.

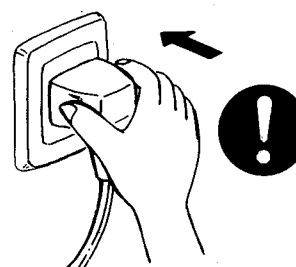

Do not scratch or process the power cord, etc.

- Do not put heavy object on the power cord, do not heat it, and do not process it. The cord may be damaged and it may cause a fire or electric shock.

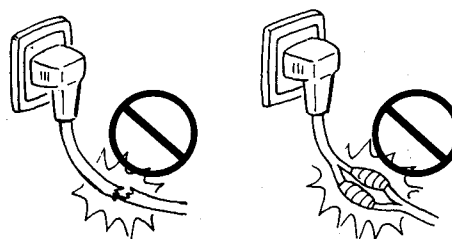

⚠ WARNING

Do not disconnect/connect the power plug during operation.

- This may cause a fire due to sparks, etc.

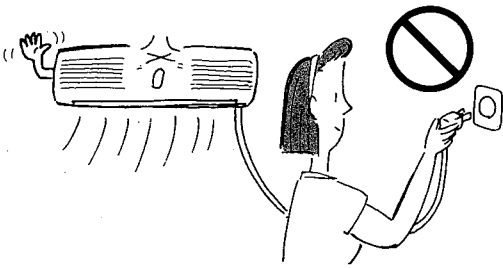

Do not expose the skin to cool air directly for long time.

- This could damage your health.

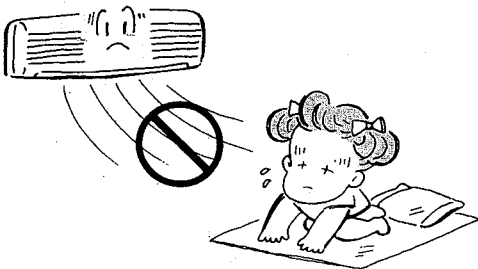

When an abnormality (smell of burning, etc) occurs, stop the air conditioner, and disconnect the power plug or turn off the breaker.

- If the unit continues to be operated in an abnormal condition, it may cause a fire, trouble, etc. In this case, consult your dealer.



Do not insert your finger or stick, etc. into the air inlet/air outlet.

- Since the fan rotates at high speed, this may cause an injury.

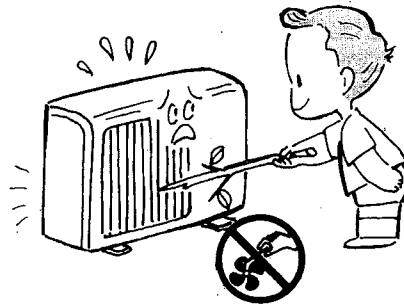

Repair or relocation should not be done by the customer.

- If this is done incorrectly, it may cause a fire, electric shock, injury by dropping of the unit, water leakage, etc. Consult your dealer.

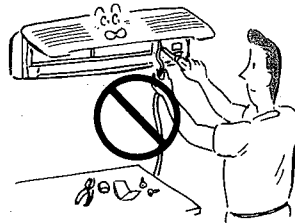

The customer should not install this unit.

- If this is done incorrectly, it may cause a fire, electric shock, injury by dropping of the unit, water leakage, etc. Consult your dealer.

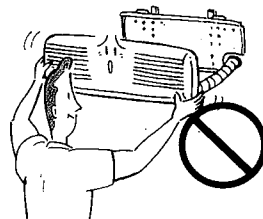

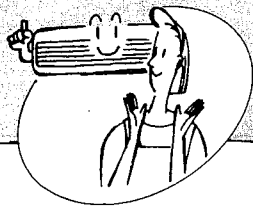

SAFETY PRECAUTIONS

⚠ CAUTION

Do not pull the power cord.

- Hold the power plug to disconnect it. The core wire of the power cord may be disconnected and it may cause a fire.

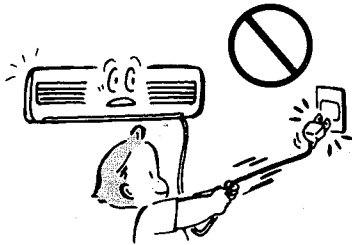

When the unit is to be cleaned, switch off, and disconnect the power plug or turn off the breaker.

- Since the fan rotates at high speed during operation, it may cause an injury.

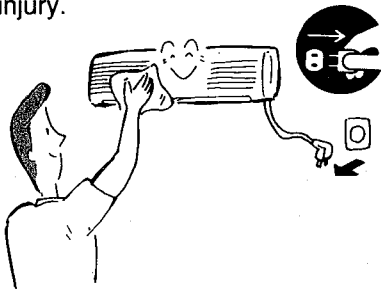

Do not operate switches with wet hands.

- It may cause an electric shock.

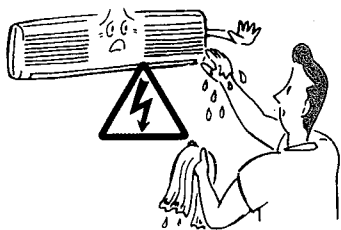

Do not clean the air conditioner with water.

- Water may enter the unit and degrade the insulation. It may cause an electric shock.



Do not put a pet or house plant where will be exposed to direct air flow.

- This could injure the pet or plant.

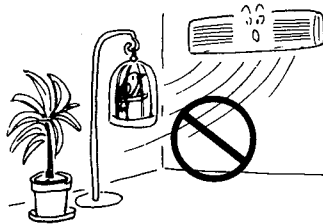

Do not apply an insecticide or flammable spray.

- It may cause a fire or deformation of the cabinet.

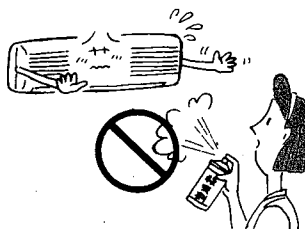

Ventilate well when used together with a stove, etc.

- An oxygen shortage may occur.

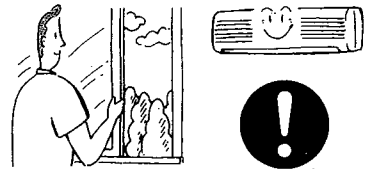

Do not use for special purposes.

- Do not use this air conditioner to preserve precision devices, food, animal, plants and art objects. It may cause deterioration of quality, etc.

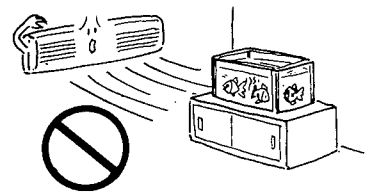

Do not put a stove, etc. where is exposed to direct air flow.

- It may cause imperfect combustion.

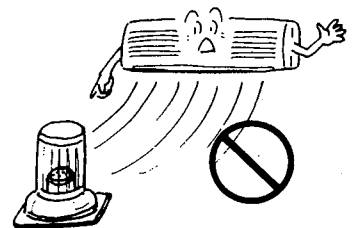

⚠ WARNING

- Consult your dealer for installing the air conditioner.

⚠ CAUTION

Apply grounding.

- Do not connect a grounding wire to a gas pipe, water pipe, lightning rod or ground wire of a telephone. If a grounding is incorrect, it may cause an electric shock.



Install an earth leakage breaker depending on the place where the air conditioner is to be installed (humid place, etc.).

- If the earth leakage breaker is not installed, it may cause an electric shock.



Do not install the unit where flammable gas could leak.

- If gas leaks and collect around the unit, it may cause an explosion.



Drain water should be fully drained.

- If the drainage route is incomplete, water may drop from the unit. It may wet and spoil furniture.

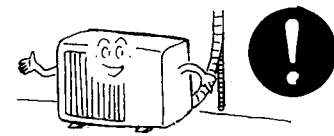

When the unit is not going to be used for a long time, disconnect the power plug or turn off the breaker.

- If not, dirt may collect and cause a fire.



Do not step on the indoor/outdoor unit and do not put anything on it.

- It may cause an injury through dropping or falling down.

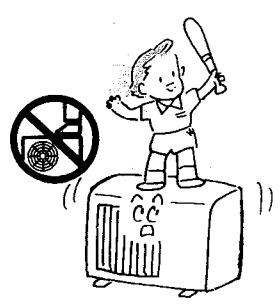

Do not leave on installation stand which is damaged.

- The unit may drop or fall down and cause an injury.

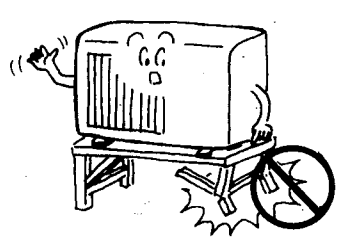

Do not operate for a long time in high humidity, e.g. leaving a door or window open.

- In the cooling mode, if it is operated in a room with high humidity (80%r.h. or more) for a long time, water condensed in the air conditioner may drop and may wet and spoil furniture, etc.

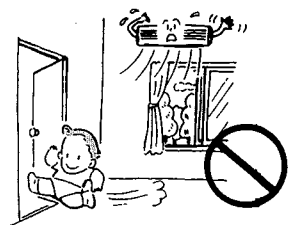

Do not step onto an unstable bench when attaching/detaching the panel.

- It may cause an injury, etc. by falling down.



When the air filter is to be removed, do not touch the metal parts of the indoor unit.

- It may cause an injury.



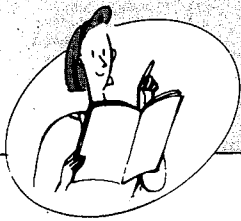

NAME OF EACH PART

Indoor unit

MSH-09NV, MSH-12NV

Air cleaning filter
(White bellows type)

Deodorizing filter
(gray sponge type)

Air filter

Vertical vanes

Front panel

Air inlet

Power supply plug

Remote control receiving section

Horizontal vane

Remote controller

MSD-18NV

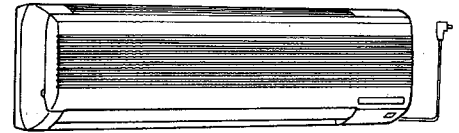

Operation section
(when the front panel is open)
MSH-09NV, MSH-12NV

Display section
MSH-09NV, MSH-12NV

Emergency operation switch

Operation Indicator lamp

Receiving section

MSH-18NV

MSH-18NV

Emergency operation switch

Operation Indicator lamp

Receiving section

Outdoor unit

MSH-09NV

MSH-12NV, MSH-18NV

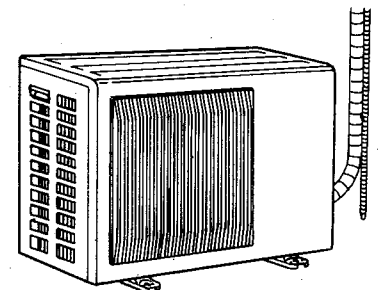
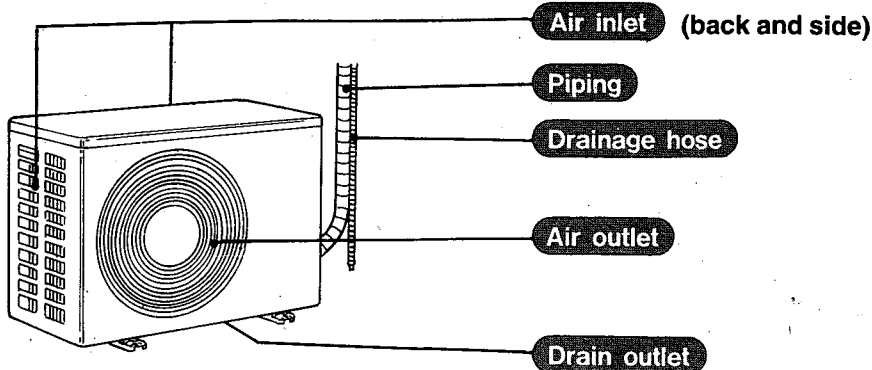

Remote controller

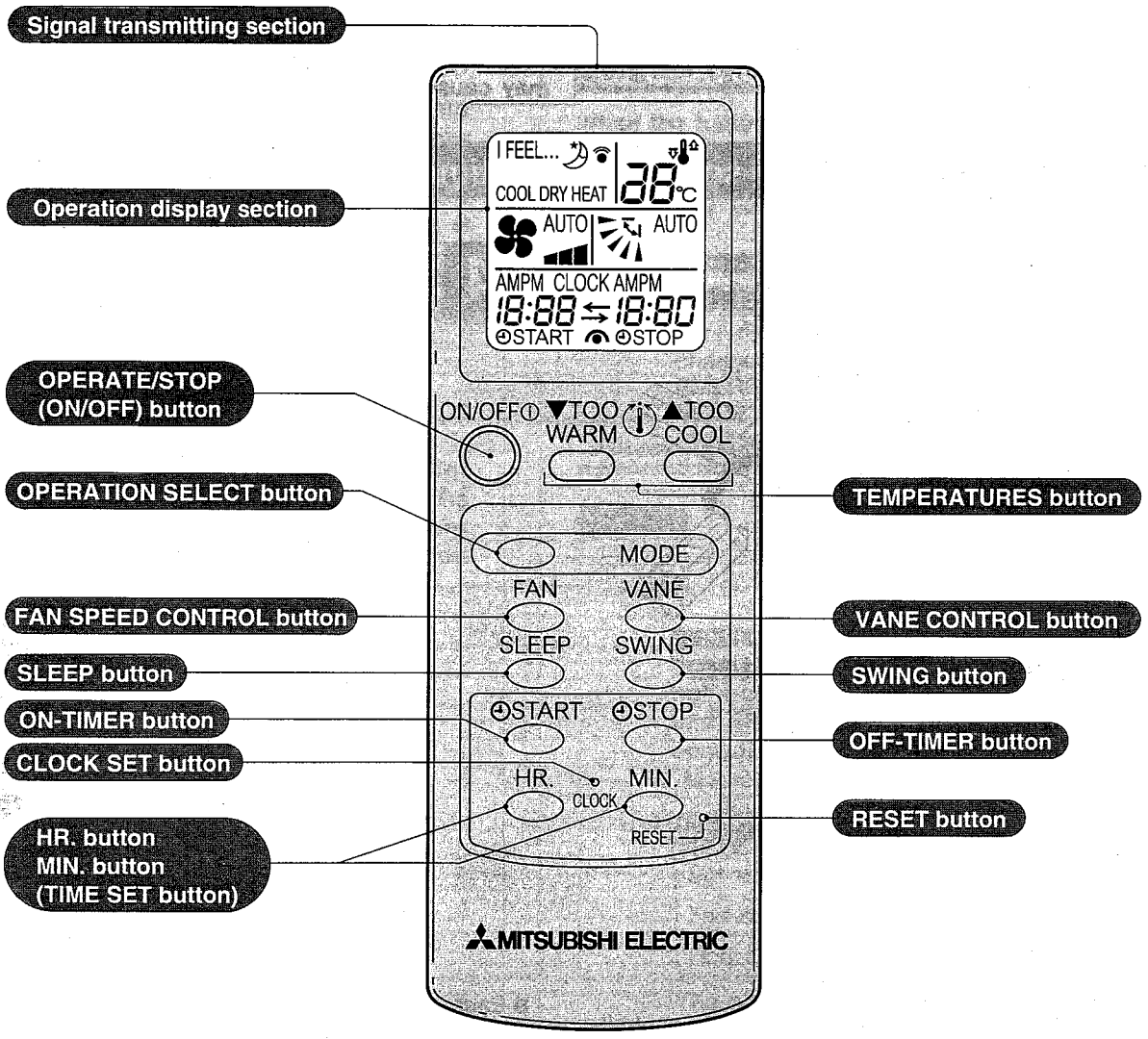

NAME OF EACH PART

(This diagram shows an overall view.)

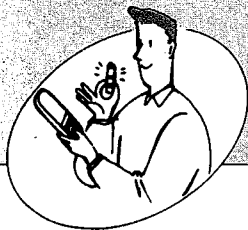

PREPARATION BEFORE OPERATION

Indoor unit

Insert the power plug into the power outlet and turn the breaker on.

WARNING

Remove dirt from the power plug and insert it securely. If dirt adheres to the plug or insertion is incomplete, it may cause a fire or electric shock.

Remote controller (how to set the current time)

1 Remove the back lid and insert batteries. And then reattach the back lid.

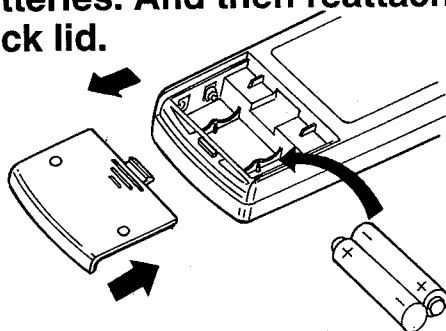

2 Press the RESET button.

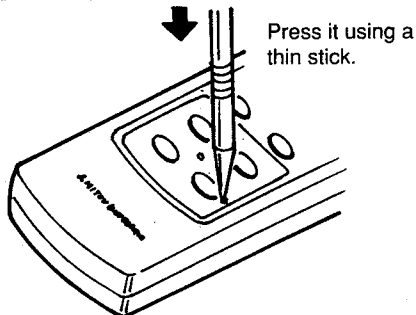

- Press the reset button.
- If the reset button is not pressed, the remote controller may not operate correctly.

3 Press the CLOCK SET button.

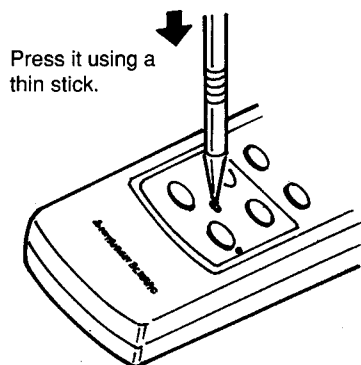

4 Press the ^{HR.} and ^{MIN.} button (TIME SET button) to set the current time.

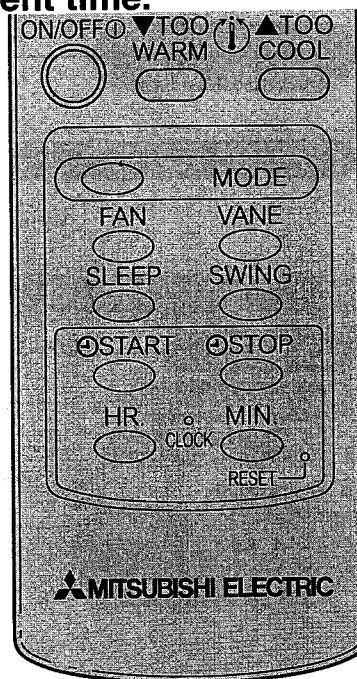

- Each time the ^{HR.} button is pressed, the set time is counted up by 1 hour, and each time the ^{MIN.} button is pressed, the set time is counted up by 1 minute.

5 Press the CLOCK SET button again.

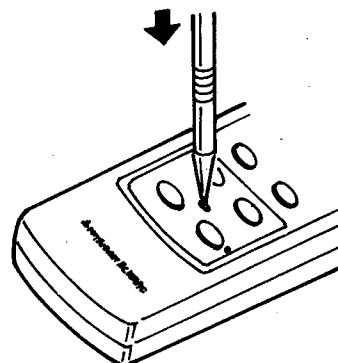

Handling of the remote controller

- The range that the signal can reach is about 6 m when pointed at the front of the indoor unit.
- When the button is pressed, one or two beeps will be heard from the indoor unit. If no sound is heard, operate again.
- Use the remote controller carefully. If it is dropped, thrown or gets wet, it may not operate.

When installing on a wall, etc.

- Install it using the remote controller installation case in a position where the signal reception sound (beep) can be heard from the indoor unit when the ON/OFF button is pressed.

How to install/remove the remote controller

Installing Insert the remote controller downward.

Removing Pull it up.

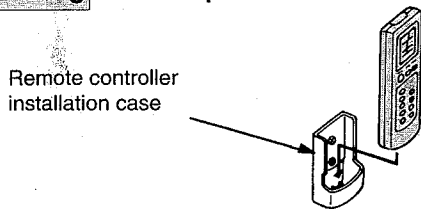

Dry-cell batteries

Reference for replacing batteries

When the signal does not operate the indoor unit, or the display becomes dim, replace the batteries with new alkaline batteries (size AAA).

- Replace 2 batteries with new batteries of the same type.
- Do not use rechargeable batteries.
- To prevent from liquid leakage, take out all batteries when the remote controller is not going to be used for a long time.
- The service life of an alkaline battery is about 1 year.

However, since the recommended usable time limit is indicated (month/year) on the bottom of the battery, a battery the time limit of which is approaching may become exhaust sooner.

WHEN THE REMOTE CONTROLLER CANNOT BE USED(EMERGENCY OPERATION)

When the batteries of the remote controller run out or remote controller malfunctions, **EMERGENCY OPERATION** can be done using the **EMERGENCY OPERATION** switch.

1 Press the **EMERGENCY OPERATION** switch.

* Each time the switch is pressed, the unit changes the **EMERGENCY COOL MODE**, **EMERGENCY HEAT MODE** and **STOP MODE**.

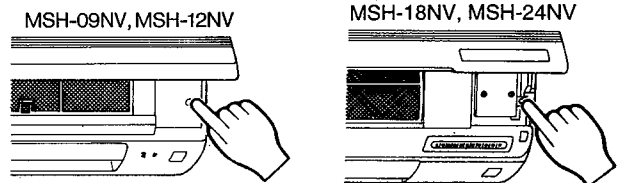

Details of operation are as shown below. However, the temperature control does not work for about 30 minutes at first and the unit is set to the continuous operation mode with the fan speed set to "Medium".

| Details of operation | COOL | HEAT |
|----------------------|--------|--------|
| Set temperature | 24°C | 24°C |
| Fan speed | Medium | Medium |
| Horizontal vane | Auto | Auto |

The operation mode is indicated on the operation indicator lamp on the indoor unit.

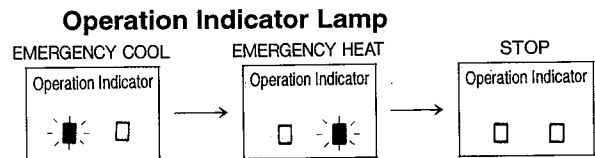

To stop EMERGENCY OPERATION, press EMERGENCY OPERATION switch again.

* Each time the switch is pressed, the unit changes the **EMERGENCY COOL MODE**, **EMERGENCY HEAT MODE** and **STOP MODE**.

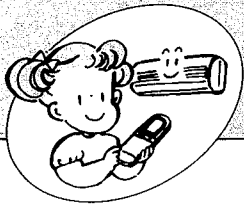

“I FEEL...” AUTO OPERATION

With the “I FEEL...” auto operation mode, the optimum room condition can be set automatically by one-touch operation.

● To start operation:



ON/OFF ⊕

Press the  button.

When the “I FEEL...” is displayed, the air conditioner is automatically controlled at the optimum temperature.

● To stop operation



ON/OFF ⊕

Press the  button

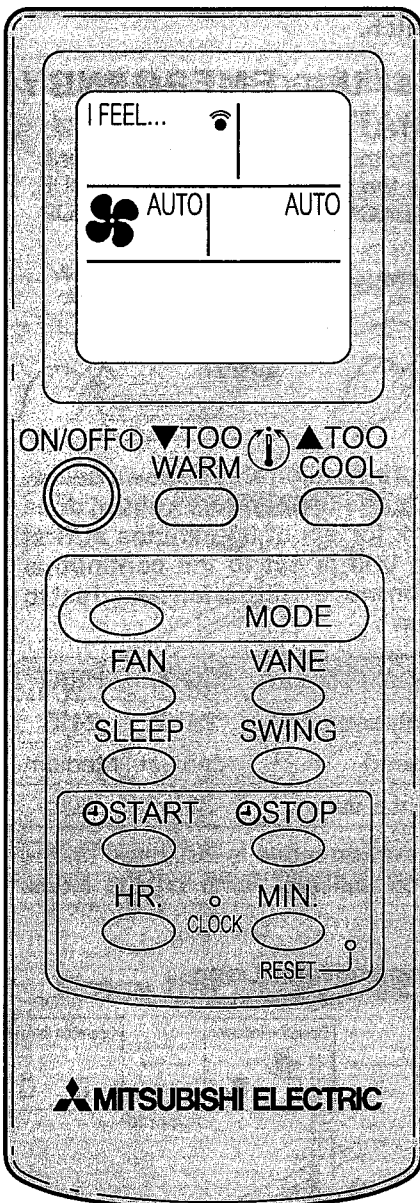

When about 15 min. passes after operation start
If you feel slightly warm,

 Press the  button to lower the temperature.

One press lowers the temperature by about 1 °C.

If you feel slightly cool,

 Press the  button to raise the temperature.

One press raises the temperature by about 1 °C.

When “I FEEL...” is not displayed, press the  MODE button to set to the “I FEEL...” auto operation mode.

Each time the button is pressed, the operation mode is changed in sequence, from “I FEEL...”, “COOL”, “DRY” to “HEAT”.

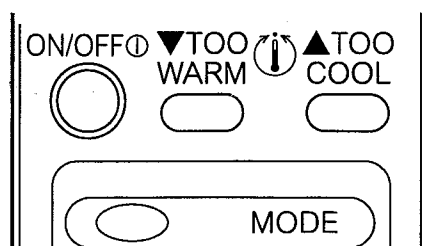

Description of "I FEEL..." mode

Details of operation

According to the room temperature when the operation starts, the operation mode is automatically selected between COOL, DRY and HEAT. However, when operation is started again within 2 hours after the operation is stopped, the same operation mode before it is stopped is selected. The operation mode selected first is not changed even if the room temperature changes. If the operation mode does not match the room condition, select the required operation mode by pressing the MODE button.

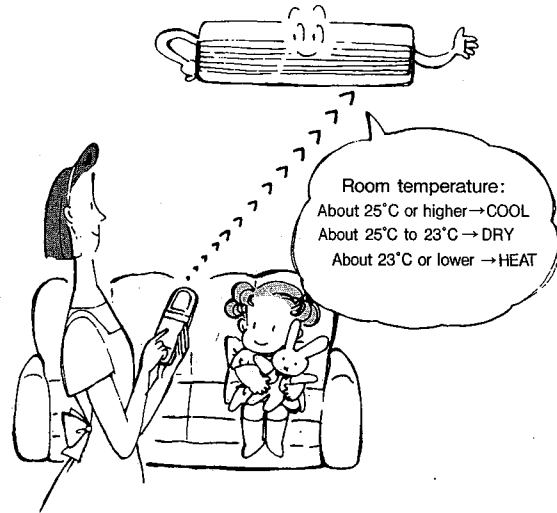

Details of "I FEEL..." auto operation

| Room temperature when started | Operation mode | Target temperature (initial state) |
|-------------------------------|----------------|------------------------------------|
| About 25°C or higher | COOL | About 24°C |
| About 25°C to 23°C | DRY | - |
| About 23°C or lower | HEAT | About 26°C |

NOTE

COOL: When the room temperature is 2°C higher than the set temperature, the set temperature may not be decreased since the unit operates at high power. In this case, wait until the room temperature drops to within 2°C of set temperature.

HEAT: When the room temperature is 2°C lower than the set temperature, the set temperature may not be increased since the unit operates at high power. In this case, wait until the room temperature rises to within 2°C of set temperature.

Display details on the indoor unit

The operation indicator at the right side of the indoor unit indicate the operation state.

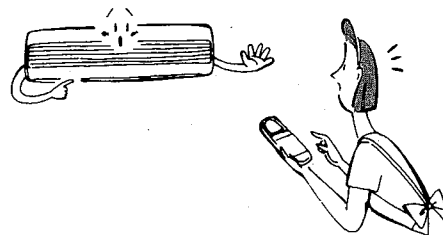

Operation Indicator



Operation Indicator lamp

| Indication | Operation state | Difference between set temperature and room temperature |
|------------|--|---|
| | This shows that the air conditioner is operating to reach the target temperature. Wait for some time until the target temperature is obtained. | About 2°C or more |
| | This shows that the room temperature is approaching the target temperature. | About 2°C or less |

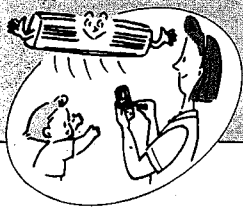

MANUAL OPERATION (COOL, DRY, HEAT)

To select the "COOL", "DRY" or "HEAT" mode

With this operation mode, the temperature and airflow direction can be finely adjusted by selecting the operation mode.

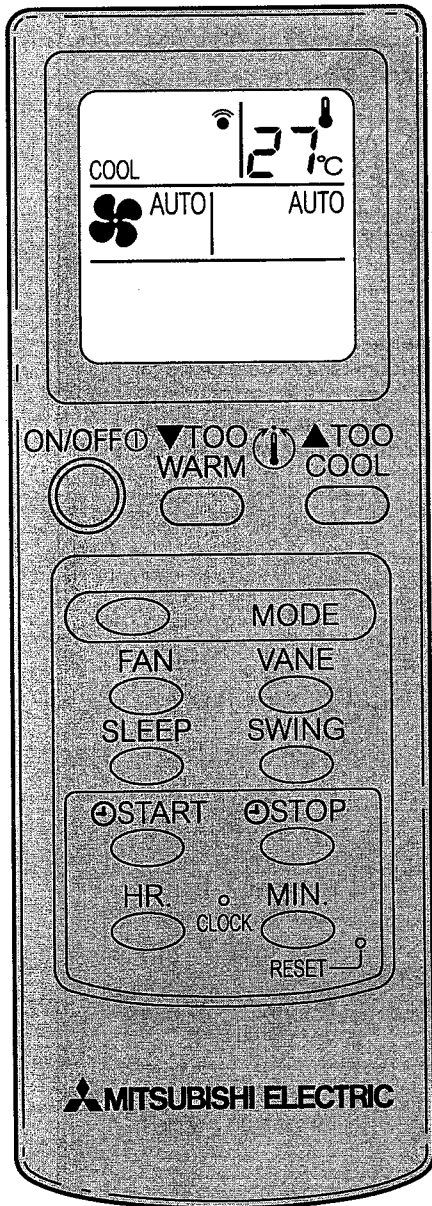

1 Press the **ON/OFF** button.



2 Select the operation mode by pressing the **MODE** button.



Each time this button is pressed, the operation mode is changed in sequence, from "I FEEL...", "COOL", "DRY", "HEAT".

● To stop operation:

Press the **ON/OFF** button.



After the operation mode is set once, the operation starts in the mode set previously from the next time by simply pressing the **ON/OFF** button.



When the set temperature is to be changed:

■ Press the **TOO WARM** button to lower the temperature.

One press lowers the temperature by about 1°C.

■ Press the **TOO COOL** button to raise the temperature.

One press raises the temperature by about 1°C.

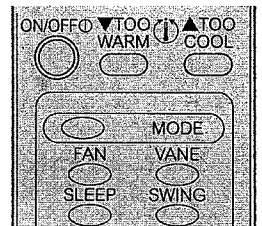

In "HEAT" operation

■ If the air conditioner absorbs too much heat from the air, the machine may be overloaded. Following a judgement made by the micro-processor, the fan in the outdoor unit is automatically stopped to protect the air conditioner. When the outdoor unit's fan is stopped, frost may form on the outdoor. This is not a problem.

In "DRY" operation

■ The temperature control (temperature setting) cannot be done.
 ■ The room temperature is slightly lowered in this operation mode.

The details displayed on the indoor unit are the same as those in the "I FEEL...". See page 9.

Note

■ When the ambient temperature is too high, the room temperature may not reach the set temperature since the unit operates to cool at high load. (COOL MODE)

CONVENIENT INFORMATION

COOL For effective cooling

- ① Close the windows and pull down blinds. Sunshine is reduced and cooling efficiency increases.
- ② Paste a heat shield film (generally available) on the window. Heat entering the room is reduced.
- ③ Block the outdoor unit from direct sunlight. This saves energy.

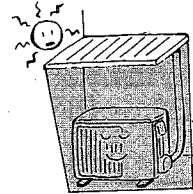

HEAT

Comfortable warmth depends on the the temperature difference from the external temperature.

It is recommended that the set temperature in the heating operation does not differ from the external temperature too much. Though there is a regional difference, as a reference, a set temperature between about 20°C and 24°C is most suitable.

DRY

The humidity at which humans feel comfortable

When air contains too much moisture, humans feel clammy. Humidity is related with temperature and wind. The humidity at which humans feel comfortable is 60%~75%RH in summer, 55%~70%RH in winter.





AIRFLOW VELOCITY AND DIRECTION ADJUSTMENT

AIR FLOW velocity and direction can be selected as required.

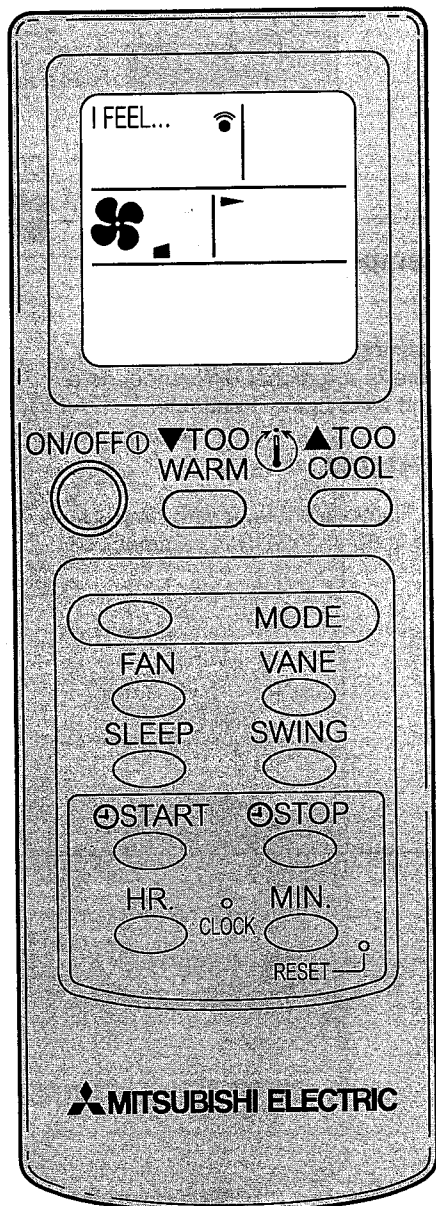

To change the AIR FLOW velocity, press the **FAN** button.

Each time the button is pressed, fan speed is changed in sequence, from [Lo] [Med] [Hi] AUTO.

- To condition the whole room, use the [Hi] mode.
- If the sound of the air conditioner operating disturbs your sleep, use the SLEEP mode (refer to page 15).

To change the AIR FLOW blowing direction vertically, press the **VANE** button.

Each time the button is pressed, angle of horizontal vane is changed in sequence, from (1) (2) (3) (4) (5) AUTO.

Recommended horizontal VANE range

Use in the AUTO position usually.

Use positions (1) or (2) in the COOL or DRY mode and positions (3) to (5) in the HEAT mode when adjusting to your requirements.

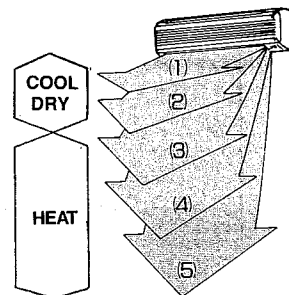

Note

- In the cooling operation, when the air conditioner is operated with AIR FLOW blowing down (4) or (5) for 1 hour, the AIR FLOW direction is automatically set to level to prevent condensed water from dropping.
- Adjust the vertical AIR FLOW direction using the remote controller. If the horizontal vane are moved manually, it may cause trouble.
- In heating operation, if the output air temperature is too low or when defrosting is done, the horizontal vane position is set to (1).

AUTO AIR FLOW DIRECTION CONTROL OPERATION

◆ When the AUTO mode is selected with the  button, the position of the horizontal vane are automatically set to correspond to the operation mode to perform effective operation.

(1) HEAT • When the output air temperature is too low, the air is blown out horizontally.

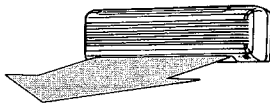

• When the output air temperature rises, the air is blown out downwards.

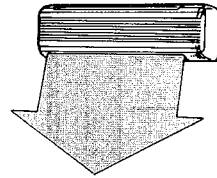

(2) COOL, DRY • The AIR FLOW blows level.



 To change the horizontal direction of the AIR FLOW move the vertical vanes manually.

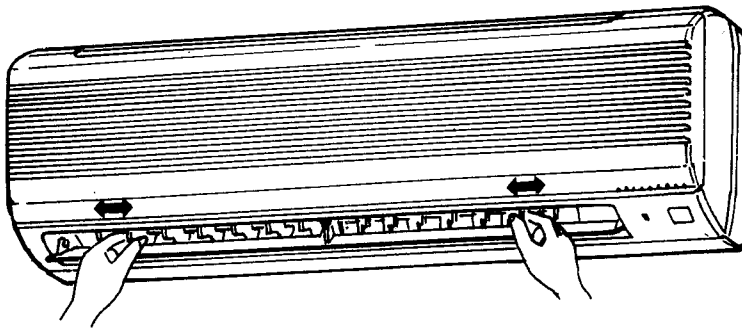

Adjust the vanes before operation starts.
Since the horizontal vane move automatically, your fingers may be caught.



SLEEP MODE

Perform the following operations while the unit is running.

Use this mode to reduce air flow sound when sleeping, etc.

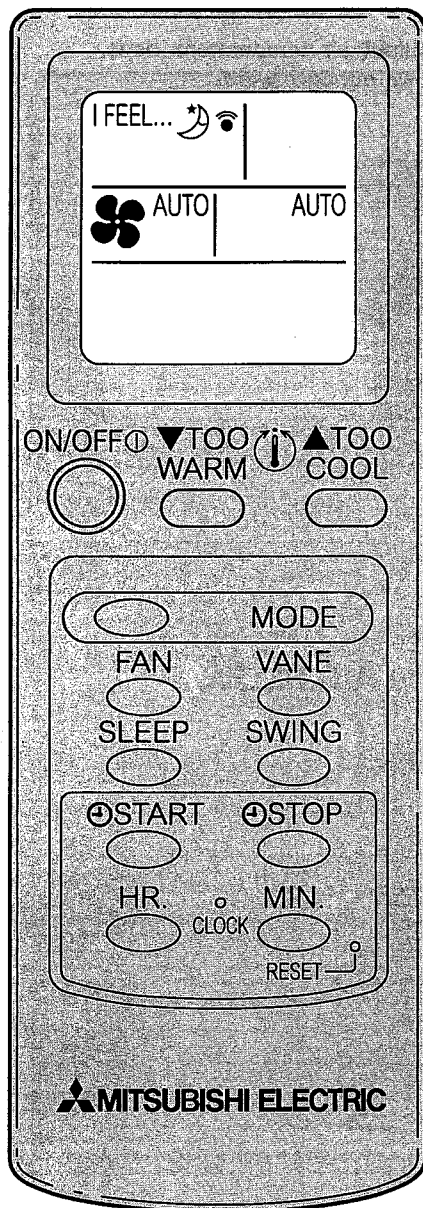

Press the  button.

● To release the SLEEP mode;

Press the  button again.

- The air flow sound from the indoor unit is decreased.
- When the  button is pressed during the SLEEP mode, the SLEEP mode is released.

Note

- Use the sleep mode when you are going to bed. If this mode is used in the day, the capacity is reduced since the ambient temperature is too high. (COOL MODE)

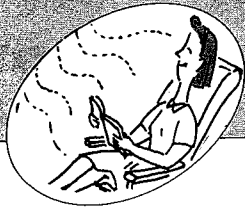

SWING OPERATION

Perform the following operations while the unit is running.

For AIR FLOW to reach all corners of the room or to strike a point directly, use the swing operation.

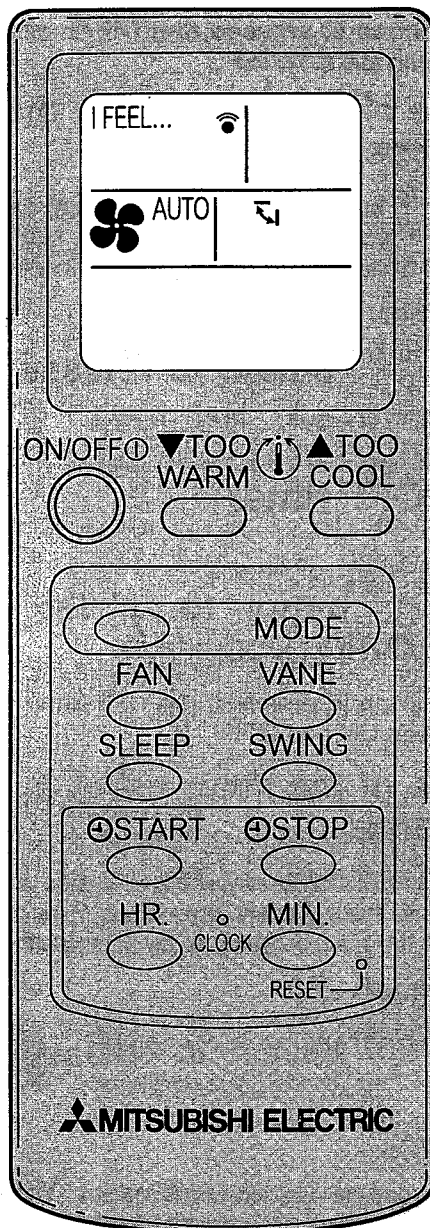

Press the ^{SWING} button.

● To release the SWING operation mode;

Press the ^{SWING} button again.

■ If the ^{VANE} button is pressed during swing operation, swing operation is released.

SLEEP MODE

SWING OPERATION

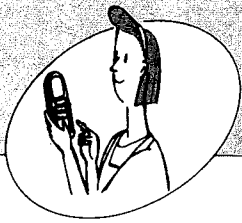

TIMER OPERATION (ON/OFF TIMER)

TIMER

It is convenient to set the timer for the time when you go to bed, when you get home, when you get up, etc.

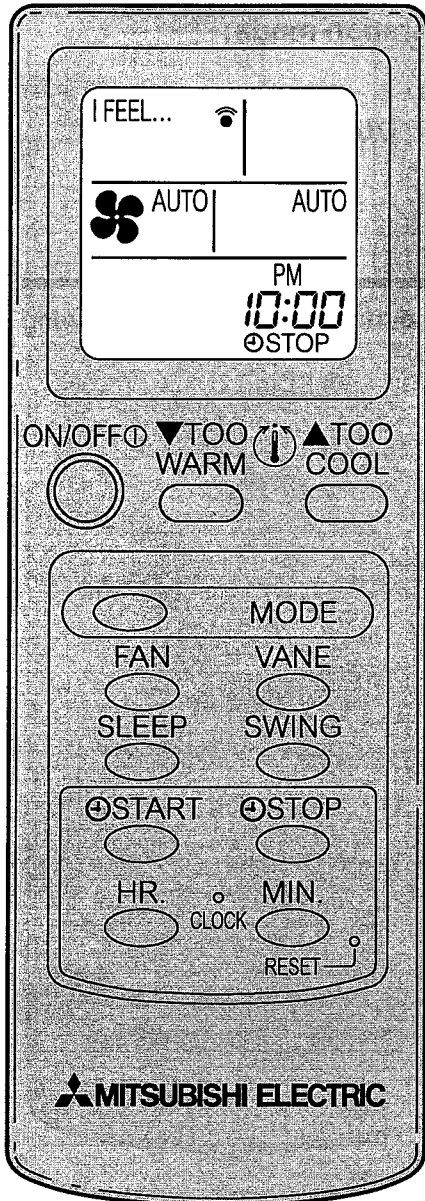

How to set the ON timer

1

Press the \oplus START button to set the ON timer mode during operation.

Each time the button is pressed, the ON timer mode alternates between ON and OFF.

2

Set the time of the timer using the HR. and MIN. buttons.

Each time the HR. button is pressed, the set time is counted up by 1 hour; each time the MIN. button is pressed, the set time is counted up by 10 minutes.

● To release the ON timer:

Press the \oplus START button to release the timer.

How to set the OFF timer

1

Press the \oplus STOP button to set the OFF timer mode during operation.

Each time the button is pressed, the OFF timer mode alternates between ON and OFF.

2

Set the time of the timer using the HR. and MIN. buttons.

Each time the HR. button is pressed, the set time is counted up by 1 hour; each time the MIN. button is pressed, the set time is counted up by 10 minutes.

● To release the OFF timer:

Press the \oplus STOP button to release the timer.

Programming timer operation

The ON timer and OFF timer can be used in combination. The timer of the set time which is reached first will operate first. ("↔" mark indicates the order of timer operations.)

■ If the current time has not been set, the timer operation cannot be done.

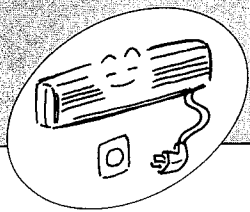

WHEN THE AIR CONDITIONER IS NOT GOING TO BE USED FOR A LONG TIME

When it is not going to be used for a long time:

1 Perform FAN operation for 3 or 4 hours to dry the inside of the air conditioner.

- To perform FAN operation, the highest set temperature is selected the MANUAL COOL OPERATION mode. (Page 11)

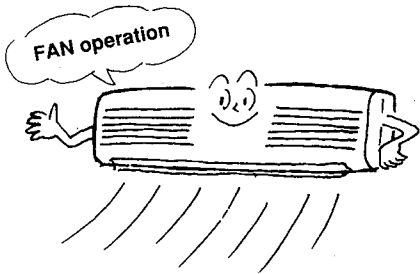

2 Turn off the breaker, then disconnect the power plug.

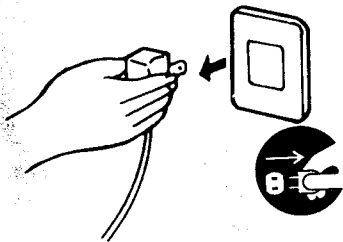

⚠ CAUTION

Disconnect the power plug or turn off the breaker when the air conditioner is not going to be used for a long time.

Dirt may collect and may cause a fire.

3 Remove the batteries from the remote controller.

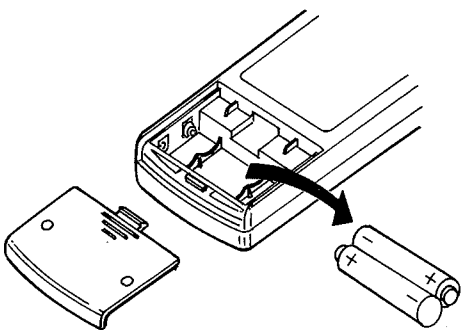

When the air conditioner is to be used again:

1 Clean the air filter and install it in the indoor unit.
(Refer to page 20 for cleaning it.)

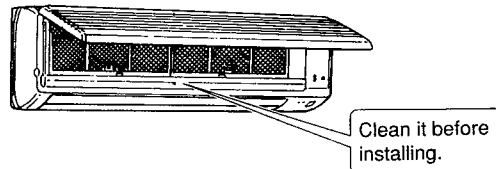

2 Check that the air inlet and outlet of the indoor/outdoor unit are not blocked.

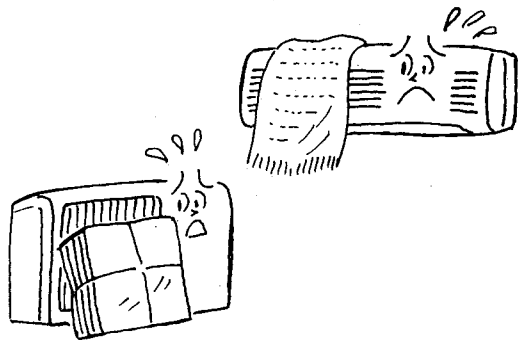

3 Check that the ground wire is connected correctly. It may be connected to the indoor unit side.

⚠ CAUTION

Apply grounding.

Do not connect a grounding wire to a gas pipe, water pipe, lightning rod or ground wire of a telephone. If a grounding is incorrect, it may cause an electric shock.

TIMER OPERATION (ON/OFF TIMER)

WHEN THE AIR CONDITIONER IS NOT GOING TO BE USED FOR A LONG TIME

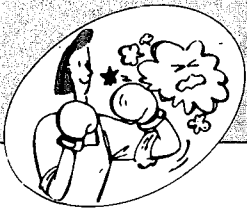

MAINTENANCE

Before starting maintenance

Turn off the breaker, then disconnect the power plug.

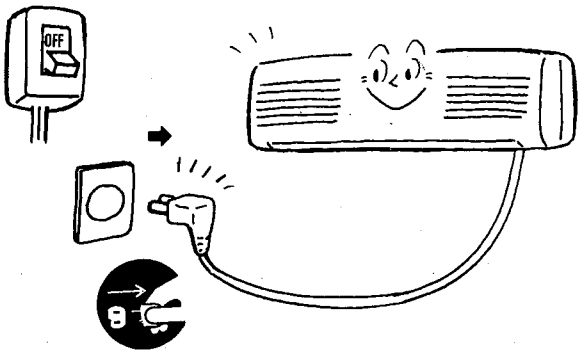

⚠ CAUTION

When the unit is to be cleaned, switch off and disconnect the power plug or turn off the breaker.

Since the fan rotates at high speed during operation, it may cause an injury.

Cleaning the indoor unit

Clean using soft dry cloth.

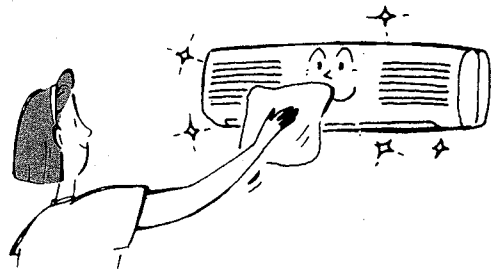

Do not use gasoline, benzene, polishing powder and detergent. And do not spray with insecticide. The unit may be damaged.



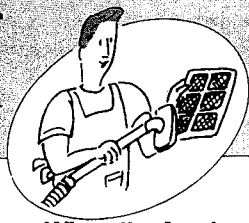

CLEANING THE AIR FILTER / DEODORIZING FILTER

When the front panel is to be opened, do not open it up to the level position. If you do, the front panel may come off.

Cleaning the air filter

(about once every 2 weeks)

1 Remove the air filter.

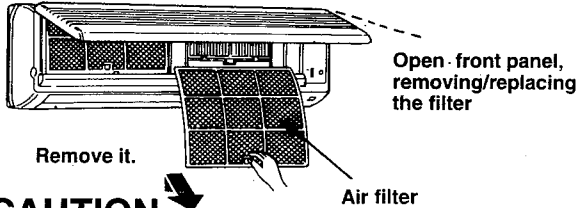

CAUTION

When the air filter is to be removed, do not touch the metal parts of the indoor unit. It may cause an injury.

2 Clean dirt from the air filter using a vacuum cleaner or by washing with water.

- If dirt is conspicuous, wash with a solution of detergent in lukewarm water.
- If hot water (50°C or more) is used, it may be deformed.

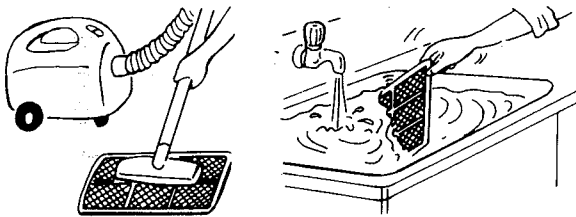

3 After washing with water, dry well in the shade.

- Do not expose the air filter to direct sunlight or heat from a fire when drying it.

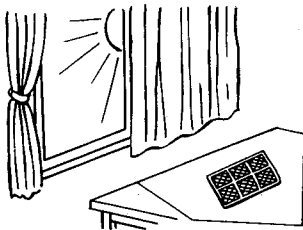

4 Install the air filter.

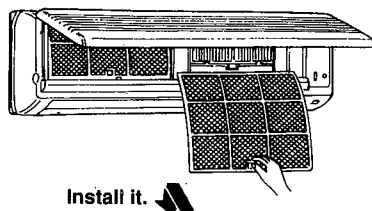

Cleaning the deodorizing filter

(about once every 2 weeks)

1 Remove the air filter and then remove the deodorizing filter (gray sponge type).

- The deodorizing filter is harmless to humans. However, to keep its effect, be sure to hold the frame and do not touch the surface of the filter with your hand.

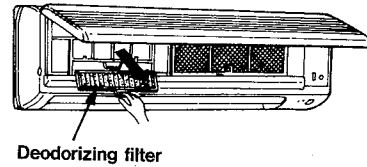

2 Soak the filter together with frame in lukewarm water for about 15 minutes.

- If dirt is conspicuous, use a solution of detergent in lukewarm water.
- Do not use a scrubbing brush or sponge. It may damage the surface of the filter.
- Do not use a chlorine detergent.

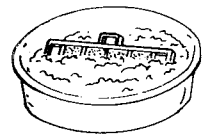

3 After washing with water/lukewarm water, dry completely in the shade.

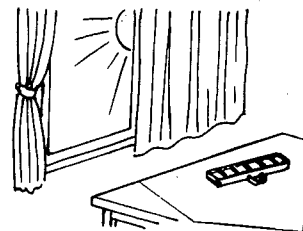

4 Install the deodorizing filter (gray sponge type) and then install the air filter.

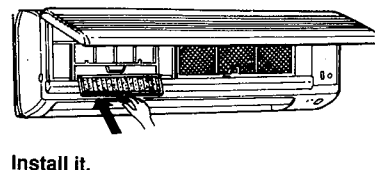



REPLACEMENT OF THE DEODORIZING FILTER/AIR CLEANING FILTER

When the capacity is lowered because of dirt, etc., it is necessary to replace the deodorizing filter/air cleaning filter.

Deodorizing filter replacement (replace about once a year)

1 Remove the air filter.

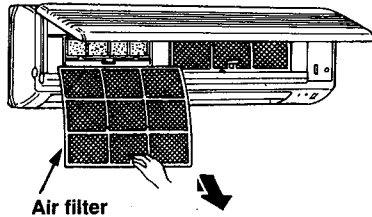

2 Remove the deodorizing filter (gray sponge type).

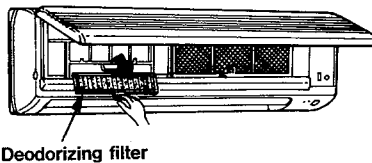

3 Install a new deodorizing filter.

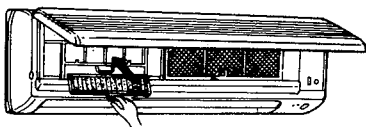

4 Install the air filter. (Securely close the front panel.)

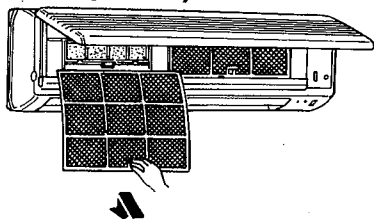

Deodorizing filter

- Cleaning is necessary about once every 2 weeks. However, if dirt is conspicuous, clean more often.
- When the color of the filter is not restored even if the filter is washed following the procedure shown on page 20 or when the filter becomes black, replace the filter with a new one.
- Standard interval for the filter replacement is about 1 year.

Air cleaning filter replacement (replace about once every 4 months)

1 Remove the air filter.

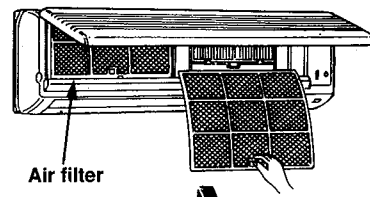

2 Remove the air cleaning filter. (white bellow type).

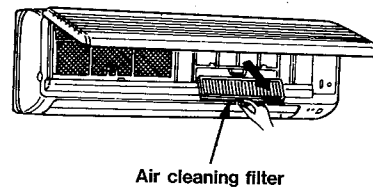

3 Install a new air cleaning filter.

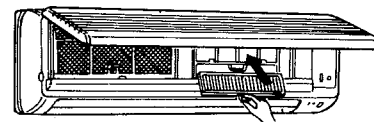

4 Install the air filter. (Securely close the front panel.)

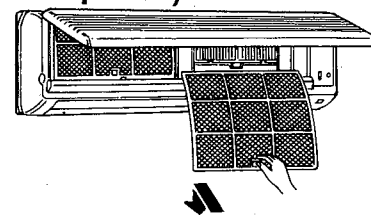

Air cleaning filter

- If the air cleaning filter is clogged, it may lower the unit's capacity or cause condensation at the air outlet.
- The air cleaning filter is disposable. The standard usable term is about 4 months. However, if the color of the filter turns to dark brown, replace soon.

Optional parts Optional parts are available from your local dealer.

| Name of part | Type name |
|---------------------|---|
| DEODORIZING FILTER | MAC-1500DF (for MSH-09/12) MAC-1600DF (for MSH-18/24) |
| AIR CLEANING FILTER | MAC-1000FT (for MSH-09/12) MAC-1100FT (for MSH-18/24) |

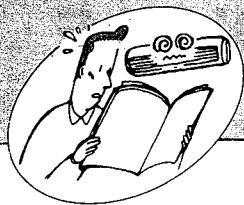

BEFORE CONTACTING THE SERVICEMAN, CHECK THE FOLLOWING AGAIN

The air conditioner cannot be operated.

Check the following.

- 1 The breaker is turned on and fuse is not blown.

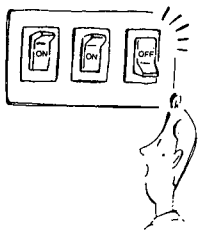

- 2 The ON-timer is not set.



Cannot be cooled and heated sufficiently.

Check the following.

- 1 The temperature setting is correct.



- 2 Air filter is not dirty.

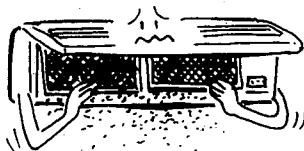

- 3 Outlet of the outdoor unit are not blocked.

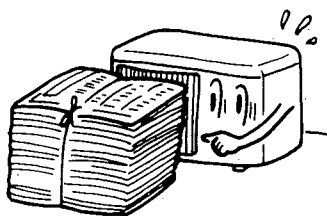

- 4 The SLEEP mode is not set in the day.

Display of the remote controller does not appear.

The remote control signal cannot be received if it is not near the air conditioner.

- 1 The batteries are exhausted.

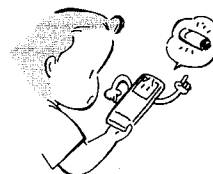

- 2 The polarity (+, -) of the batteries is confused.



When a power failure occurs. Check the following.

The air conditioner is kept stopped. After the power is restored, pressing the ON/OFF button again.

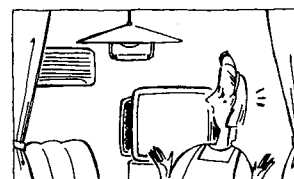

Even if the above items are checked, when the air conditioner does not recover from the trouble, stop using the air conditioner and consult your dealer.

In the following cases, stop operation and consult your dealer.

- The remote control signal may not be received in a room with an electronic ON/OFF type fluorescent lamp (inverter type fluorescent lamp, etc.) is used.
- In a weak radio wave area, when the air conditioner is operated, noise may be generated in SW radio reception.
- When thunder is heard, stop operation and pull out the power plug or turn off the breaker. Otherwise, the electrical parts may be damaged.

REPLACEMENT OF THE DEODORIZING FILTER/AIR CLEANING FILTER

BEFORE CONTACTING THE SERVICEMAN, CHECK THE FOLLOWING AGAIN



WHEN YOU THINK THAT TROUBLE HAS OCCURED.

Question

The air conditioner cannot be operated about for 3 minutes when re-started.

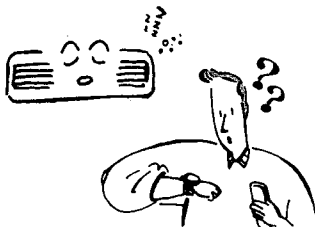

Crack sound is heard.

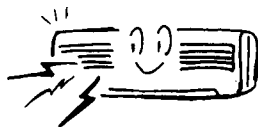

Room smells funny.

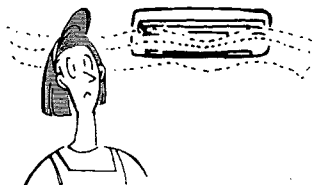

Fan stops during the DRY operation.

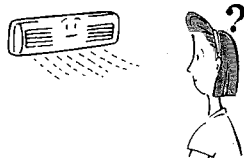

Water flowing sound is heard.

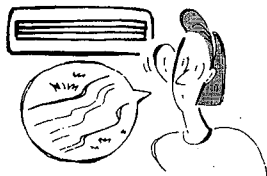

Air Flow direction is changed during operation.

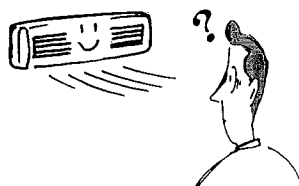

Answer (not a malfunction)

■ This protects the air conditioner by instructions from the microprocessor. Wait.

■ This sound is generated by the expansion/contraction of the front panel, etc. due to changes of temperature.

■ The air conditioner sucks an odor adhering a wall, carpet, furniture, cloth, etc. and blow it out with air.

■ If water condensing to the heat-exchanger evaporated again, the humidity increases. To prevent this, fan operation of the indoor unit stops when the room temperature has dropped sufficiently.

■ This is the sound of refrigerant flowing inside the air conditioner.
■ This is the sound of condensed water in the heat-exchanger flowing.
■ This is a sound of the heat-exchanger defrosting.

■ When the air conditioner is operated in the COOL or DRY mode, if the operation continues with air blowing down for 1 hour, the direction is automatically set to level to prevent condensed water from dropping.
■ When the air conditioner is operated in the HEAT mode, if the output air temperature is too low or when defrosting is done, the air flow direction is automatically set to level.

Question

A mechanical sound is heard from the indoor unit.



Answer (not a malfunction)

- This is the sound of the switch turning ON/OFF the fan or compressor.

Water leaks from the outdoor unit.

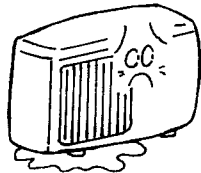

- During cooling operation, pipe or pipe connector section are cool and cause water condensed.
- Water or water vapor created by the defrosting operation is collected.
- Water adhering to the heat exchanger during heating operation drips.

Air does not flow out quickly in the heating operation.

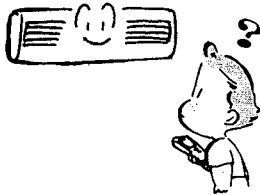

- Wait as the air conditioner is preparing to blow out warm air.

The operation is stopped for about 10 minutes in the heating operation.

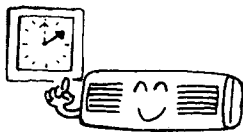

- Defrosting of the outdoor unit is being done (Defrosting operation). Since this is completed with 10 minutes, wait. (When the external temperature is too low and humidity is too high, frost is formed).

Some times, a hissing sound is heard.

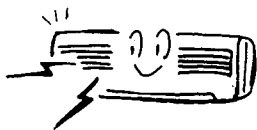

- This is the sound when the flow of refrigerant inside the air conditioner is switched.

WHEN YOU THINK THAT TROUBLE HAS OCCURED

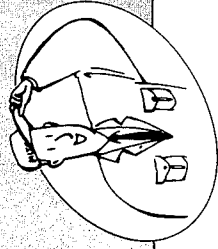

INSTALLATION, RELOCATION AND INSPECTION

Installation place

Avoid installing the air conditioner in the following places.

- Where flammable gas could leak.

⚠ Caution

Do not install the unit where flammable gas could leak.

If gas leaks and collect around the unit, it may cause an explosion.

- Where there is much machine oil.
- Salty place such as the seaside.
- Where sulfide gas is generated such as a hot spring.
- Where oil is splashed or is filled with oily smoke.

Electrical work

- Provide an exclusive circuit for power supply of the air conditioner.
- Be sure to observe the breaker capacity.

⚠ WARNING

- The customer should not install this unit. If this is done incorrectly, it may cause a fire, electric shock, injury by dropping of the unit, water leakage, etc.
- Do not connect using branched outlet or an extension cord, and do not attach many loads to one electric outlet. A fire or electric shock may result from poor contact, poor insulation, exceeding the permissible current, etc. Consult your dealer.

⚠ Caution

- Apply grounding. Do not connect a grounding wire to a gas pipe, water pipe, lightning rod or ground wire of a telephone. If a grounding is incorrect, it may cause an electric shock.
- Install an earth leakage breaker depending on the place where the air conditioner is to be installed (humid place, etc.). If the earth leakage breaker is not installed, it may cause an electric shock.

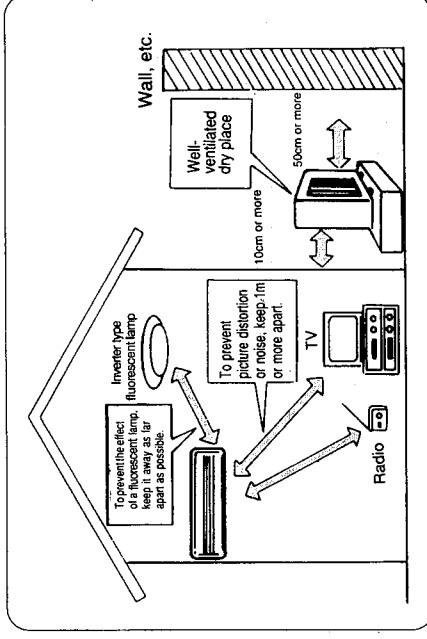

Inspection and maintenance

- When the air conditioner is used for several seasons, the capacity may be lowered due to dirt inside the unit.
- Depending on the use condition, an odor may be generated or dehumidified water may not drain out smoothly due to dirt, dust, etc.
- It is recommend to apply inspection and maintenance (charged) by a specialist in addition to normal maintenance. Consult your dealer.

Also consider operation sound

- Do not put an object around the air outlet of the outdoor unit. It may cause lowering of capacity or increase operation sound.
- If abnormal sound is heard during operation, consult your dealer.

Relocation

- When the air conditioner is to be removed or re-installed because of rebuilding, moving, etc., special techniques and work are required.

⚠ WARNING

Repair or relocation should not be done by the customer. If this is done incorrectly, it may cause a fire, electric shock, injury by dropping of the unit, water leakage, etc. Consult your dealer.

If you have any questions, consult your dealer.

NOTE

INSTALLATION, RELOCATION
AND INSPECTION



MITSUBISHI ELECTRIC CORPORATION

HEAD OFFICE MITSUBISHI DENKI BLDG. MARUNOUCHI TOKYO 100 TELEX J24532 CABLE MELCO TOKYO
